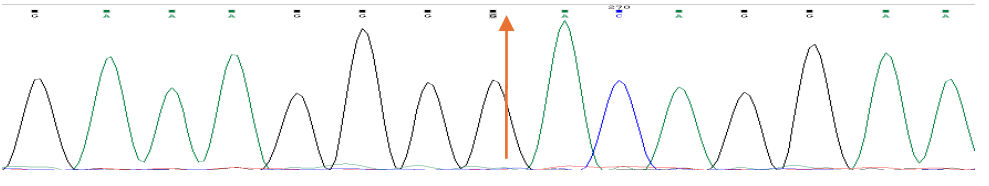
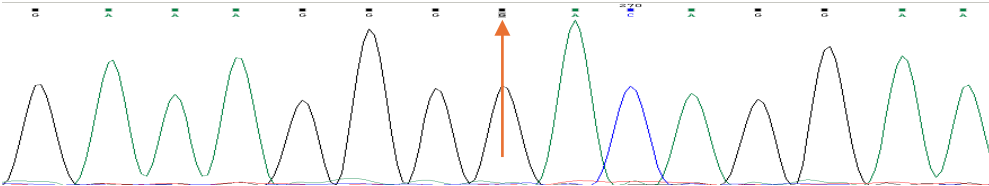
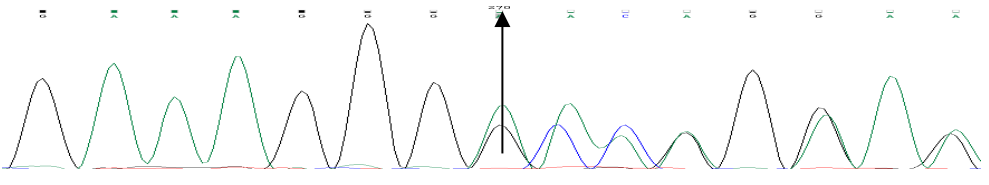
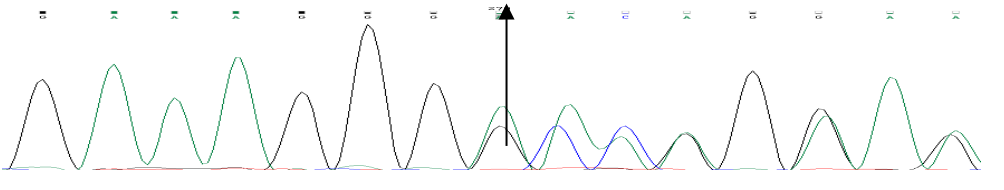
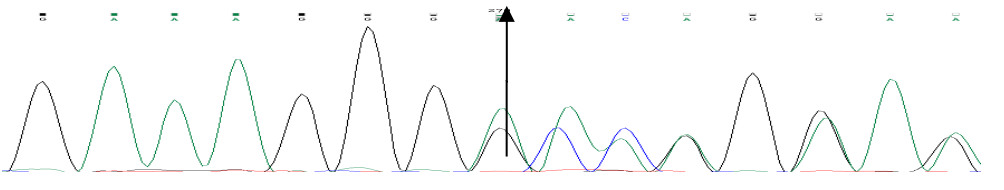
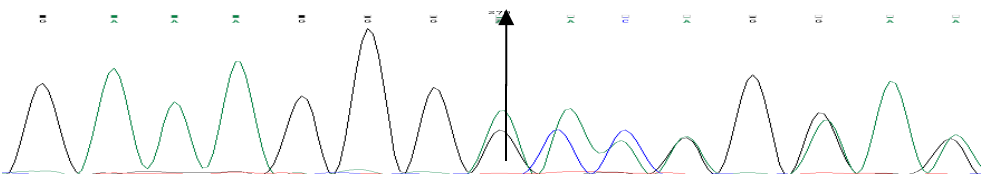
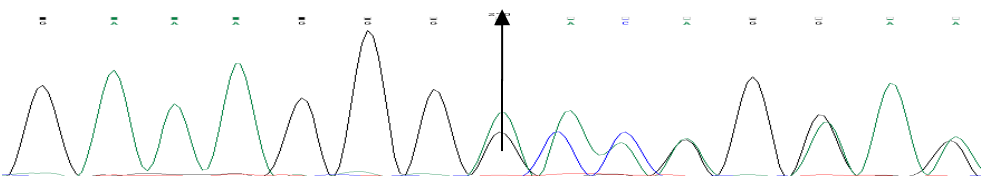
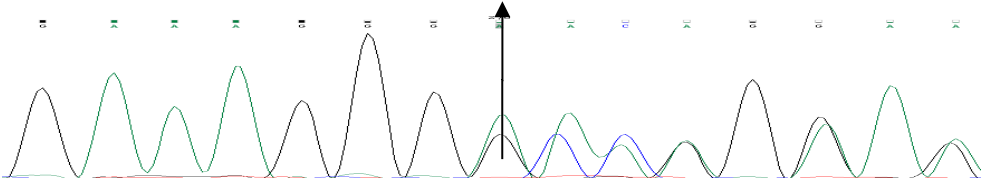
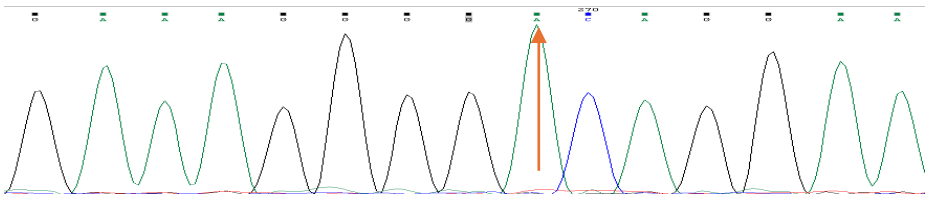
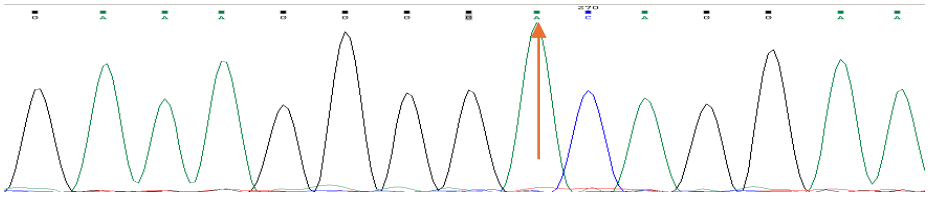
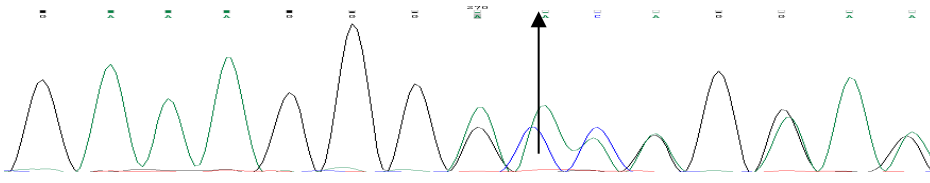

# Supplement

No	Status	<i>AHI1</i> NM-017651.4: Exon24:c.3287dupGp.G1096GfsX8 GRCh37 Chr6:g.135644341 ->G
RP101	Proband	
RP102	Affected sister	
RP103	Non-affected father	

<b>RP104</b>	<b>Non-affected mother</b>	
<b>RP105</b>	<b>Non-affected brother</b>	
<b>RP106</b>	<b>Non-affected brother</b>	
<b>RP107</b>	<b>Non-affected sister</b>	
<b>RP108</b>	<b>Non-affected sister</b>	

No	Status	<p><i>CDHR1NM_033100</i>: Exon16: c.1842delAp.A614fsX40</p> <p>GRCH37 Chr10:g .85972906 A&gt;-</p>
RP201	Proband	
RP202	Affected sister	
RP203	Non-affected mother	

<b>RP204</b>	<b>Non-affected sister</b>	
--------------	--------------------------------	--

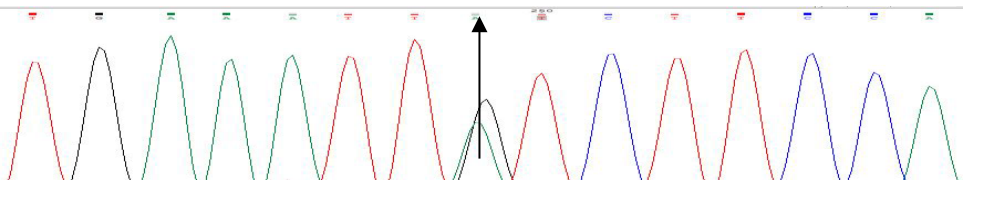
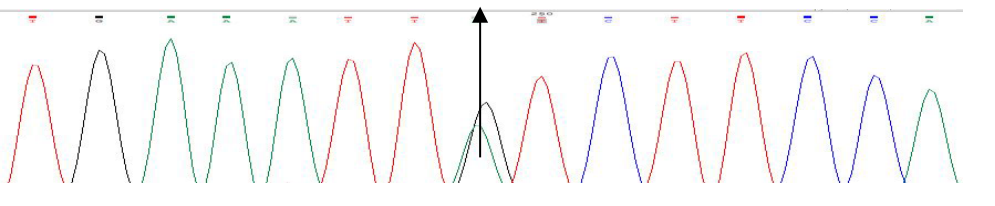
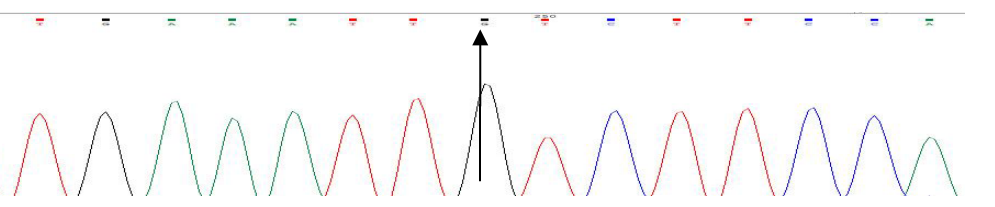

<b>No</b>	<b>Status</b>	<p><i>CNGB1NM_001297: Exon26: c.G2575A&gt;p.V859I</i>  <b>GRCh37 Chr6:g.53914030 C &gt;T</b></p>
<b>RP301</b>	<b>Proband</b>	
<b>RP302</b>	<b>Affected sister</b>	
<b>RP303</b>	<b>Affected brother</b>	

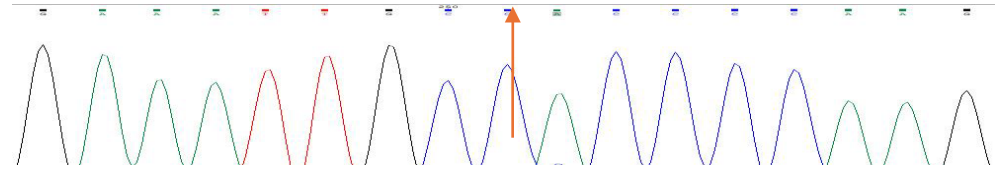
RP304	Non-affected father	
RP305	Non-affected mother	
RP306	Non-affected sister	

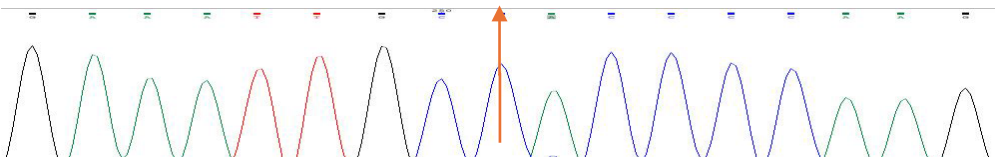
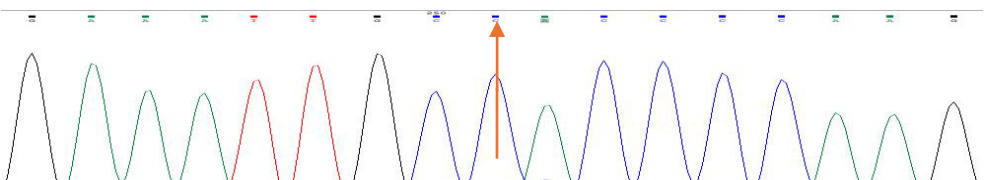
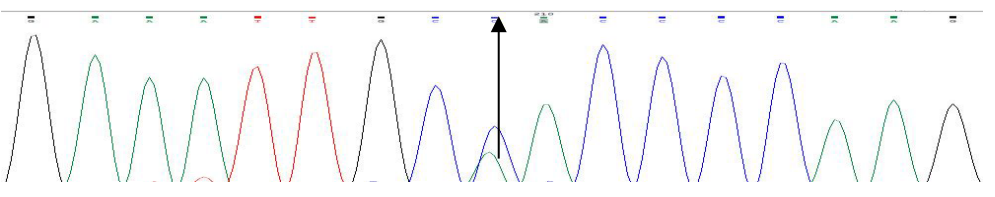
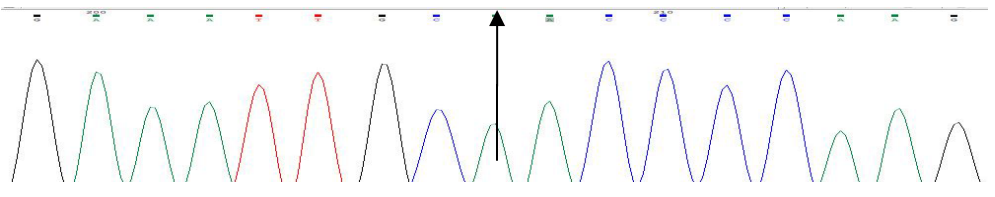
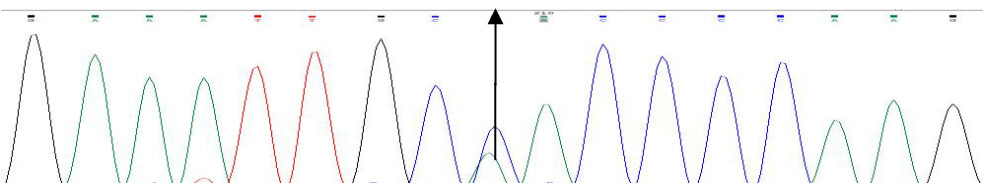
No	Status	<p><i>CNGA1NM-000087:Exon11:c.A1487Cp.Q496P</i></p> <p>GRCh37 Chr4:g.47939024 T &gt;G</p>
RP401	Proband	

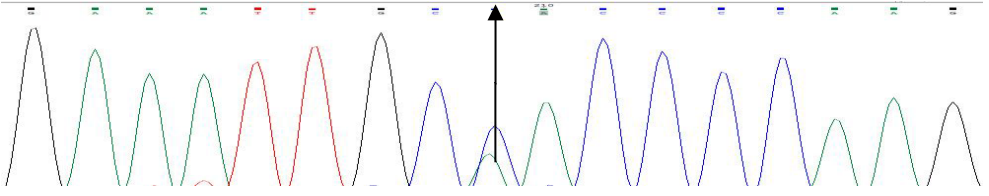
<p><b>RP402</b></p>	<p><b>Affected sister</b></p>	
<p><b>RP403</b></p>	<p><b>Affected sister</b></p>	
<p><b>RP404</b></p>	<p><b>Non-affected mother</b></p>	
<p><b>RP405</b></p>	<p><b>Non-affected sister</b></p>	
<p><b>RP406</b></p>	<p><b>Non-affected brother</b></p>	

RP407	Non-affected brother	
-------	----------------------	--

No	Status	<i>AIPL1</i> NM-014336:Exon6: c.G834A>W278X GRCh37 Chr17:g.6329101 C>T
RP501	Proband	
RP502	Affected sister	
RP503	Non-affected father	

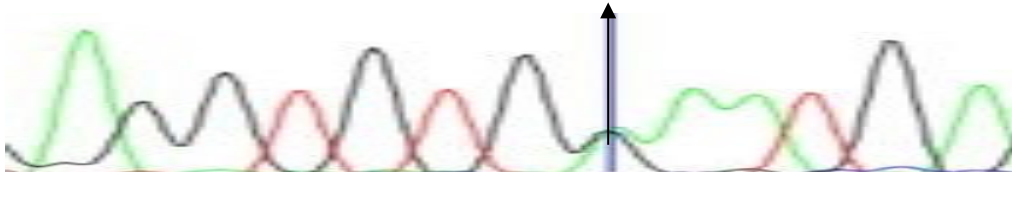
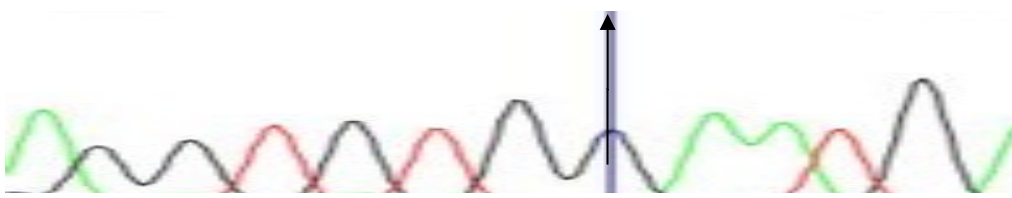
<b>RP504</b>	<b>Non-affected mother</b>	
<b>RP505</b>	<b>Non-affected sister</b>	



**Family 1**

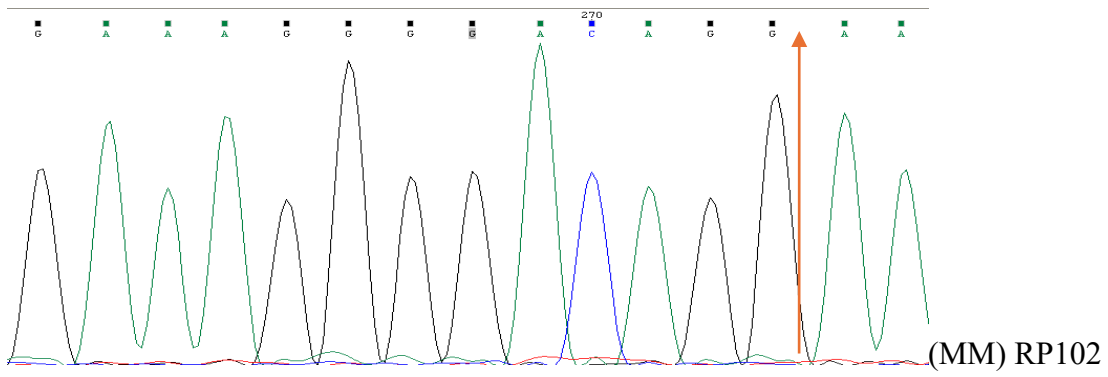
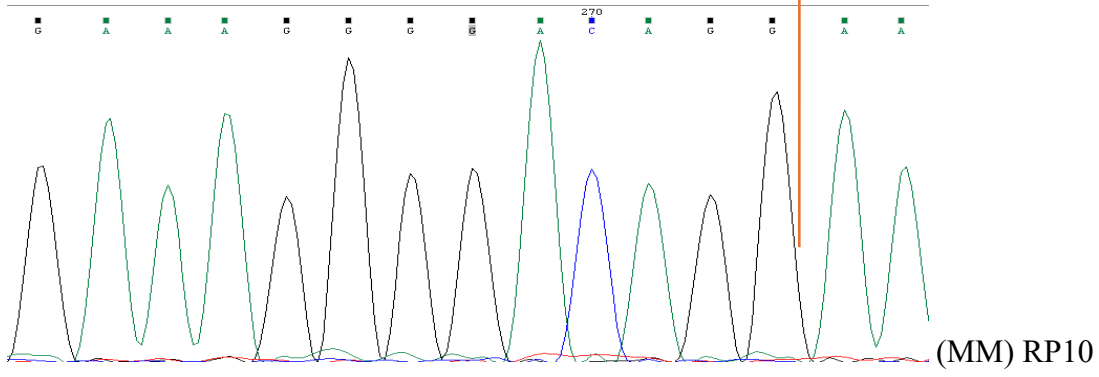

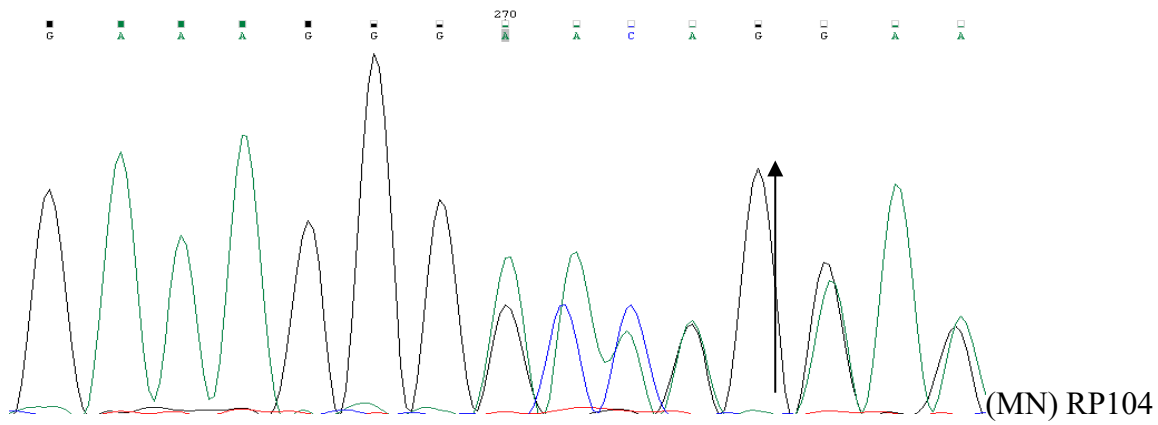
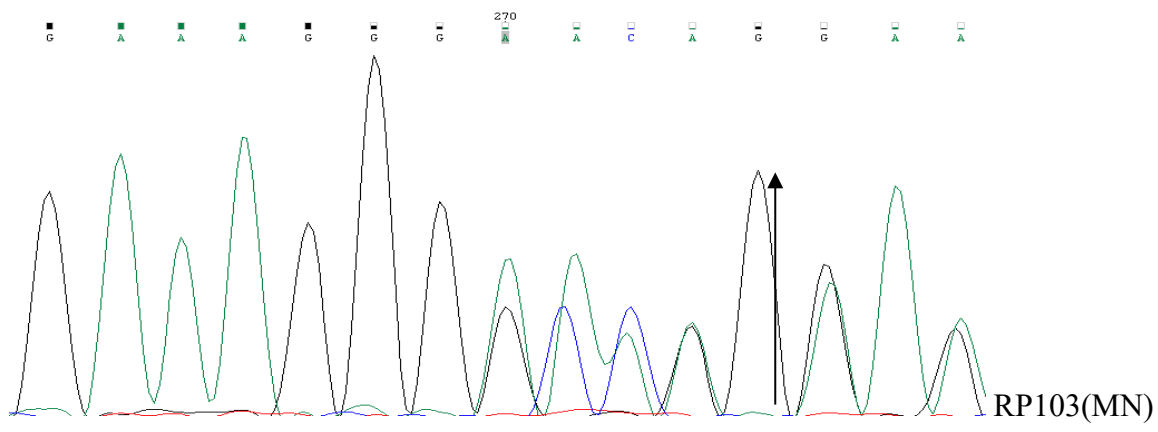

(MN) RP105

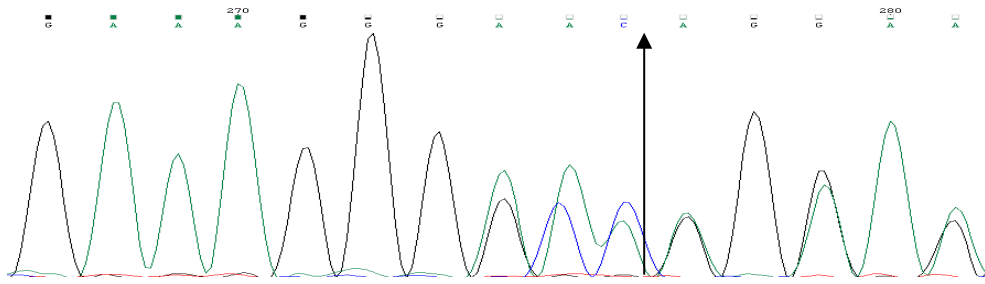

(MN)RP106

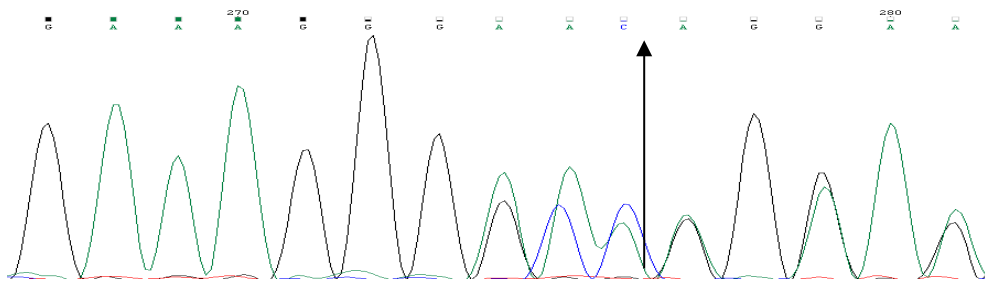

(MN) RP107

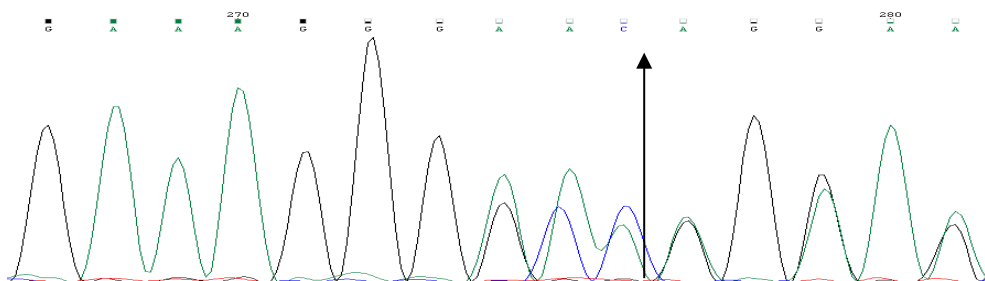

(MN)RP108

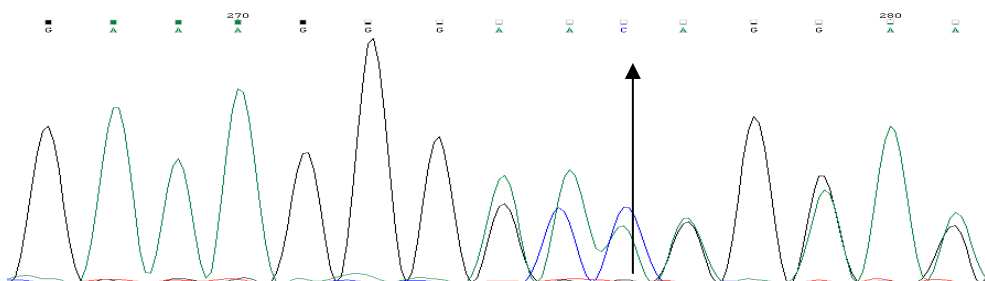



- RP
- Hemodialysis
- Hemophilia A
- اختلال جسمی حرکتی

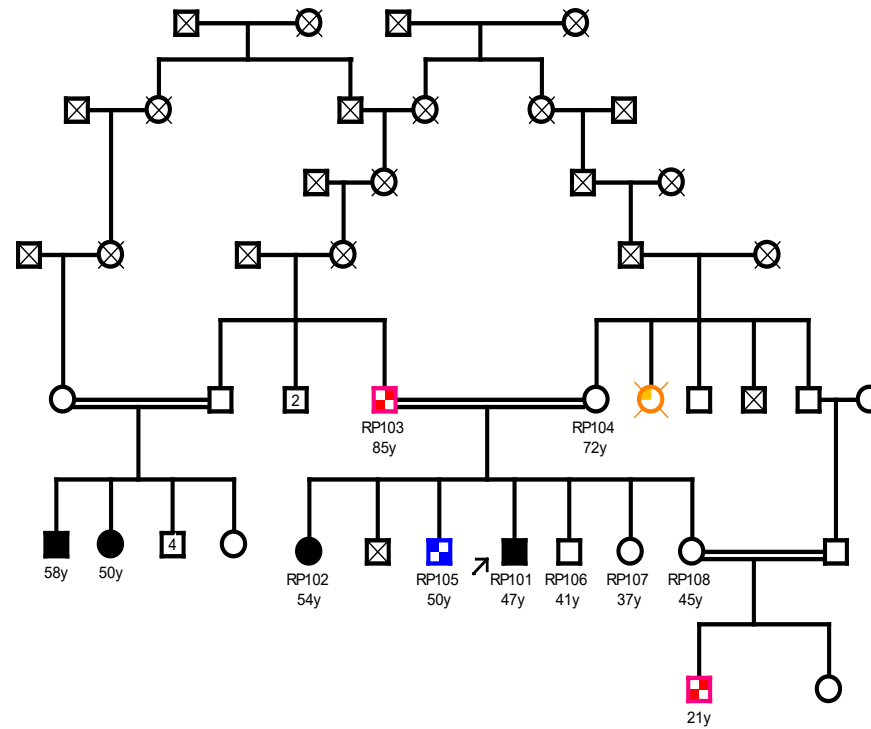

**Family 2**

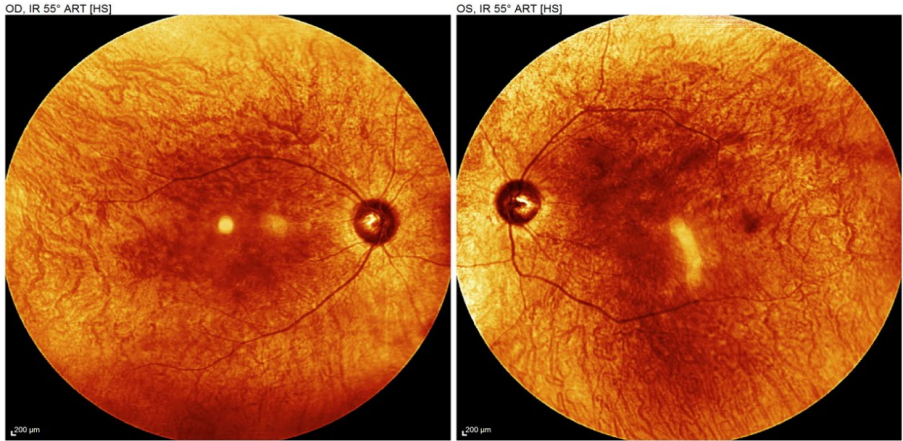

● RP

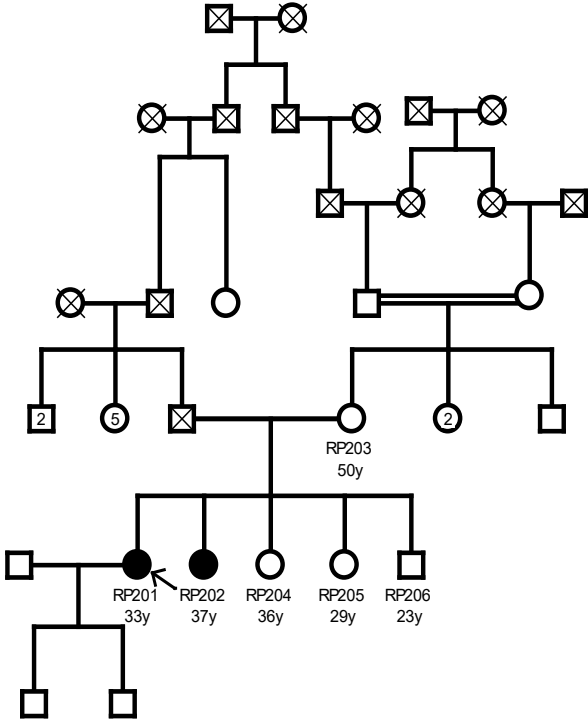

(MM) RP201

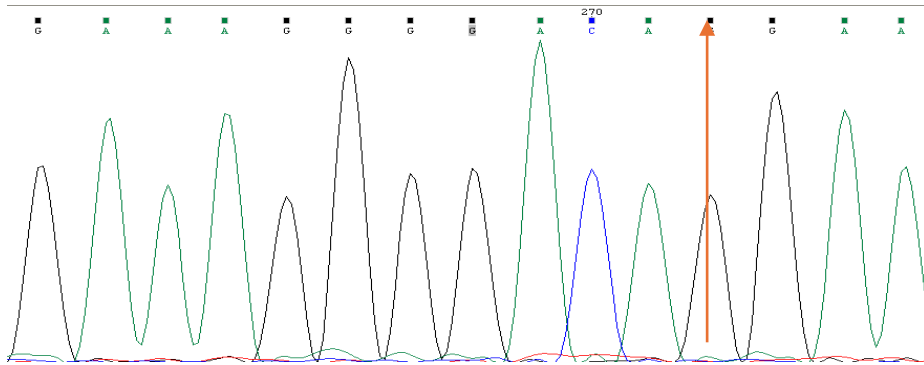

(MM) RP202

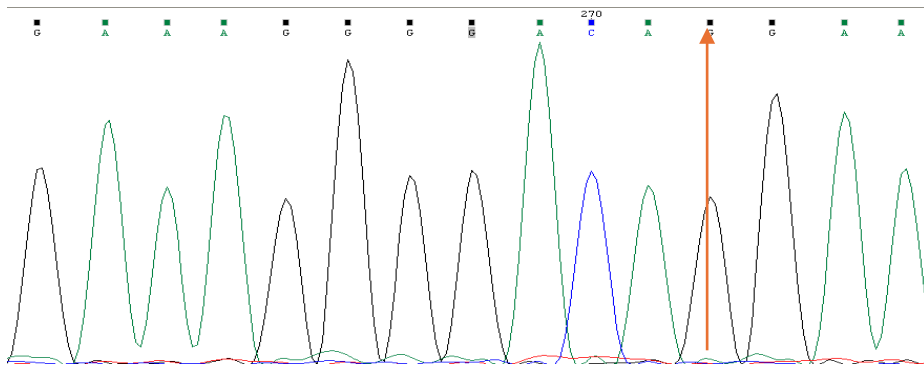

RP203(MN)

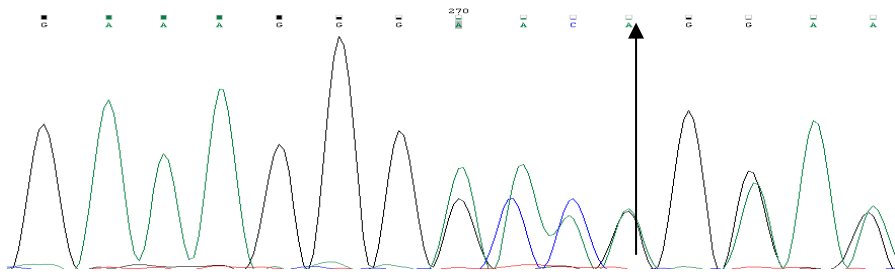

RP204 (MN)

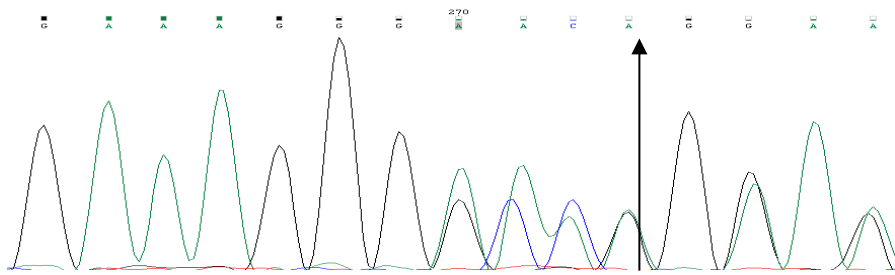



# Family 3

- RP
- Blind
- ⊕ Mild MR

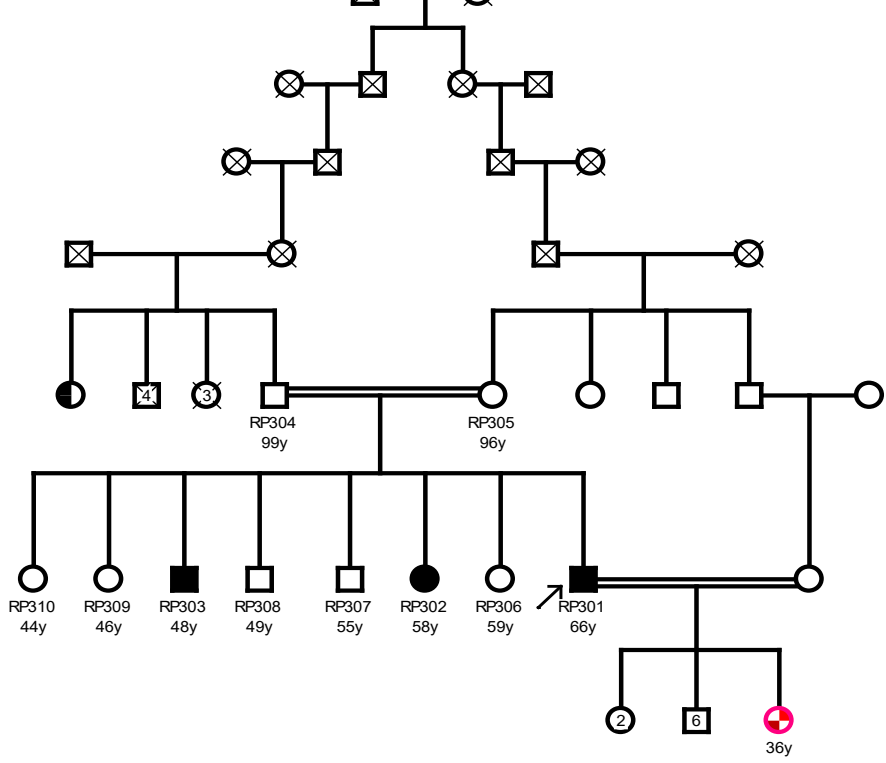

OD, IR 55° ART [HS]

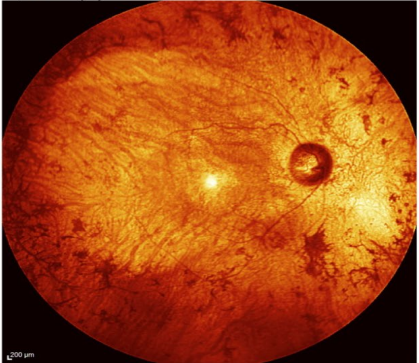

OS, IR 55° ART [HS]

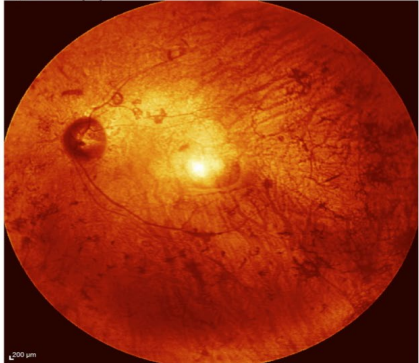

(MM)RP301

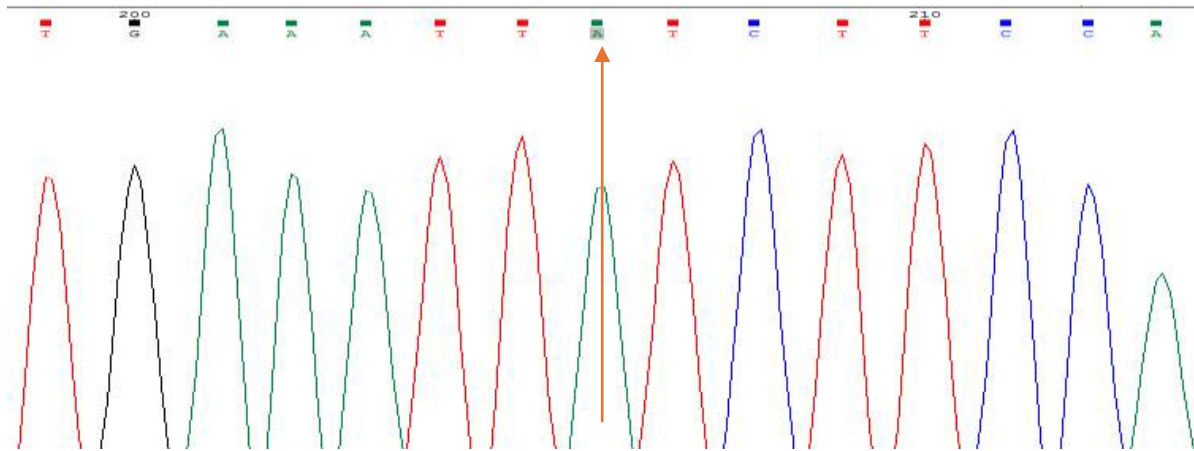

(MM)RP302

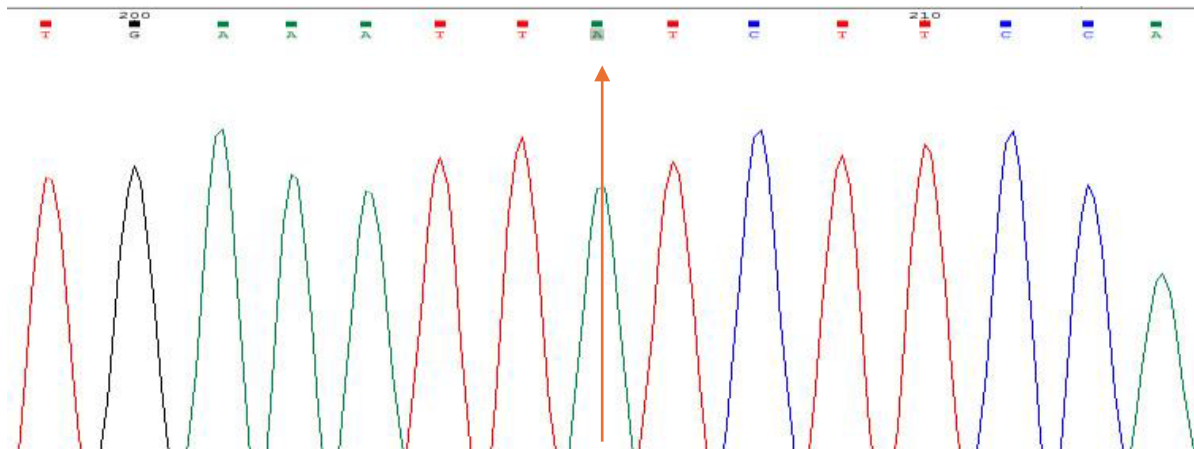

(MM)RP303

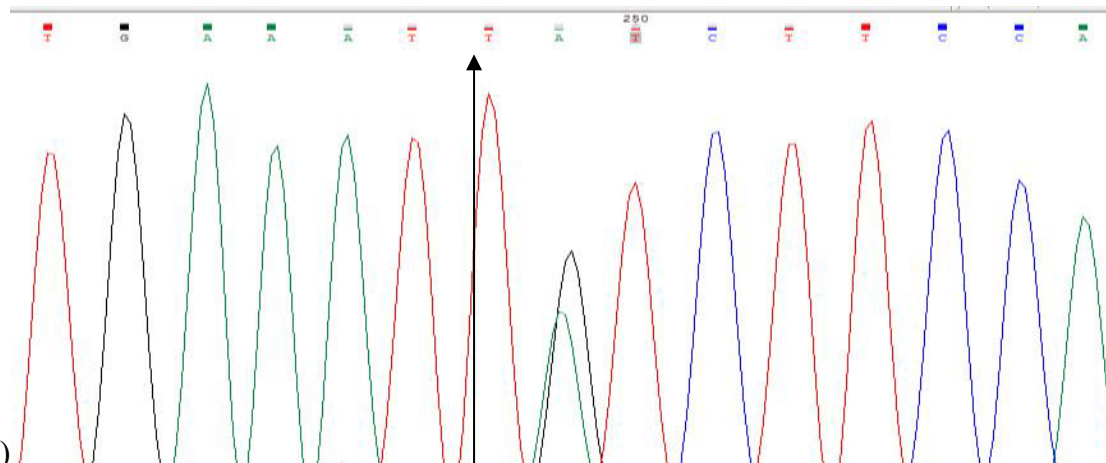
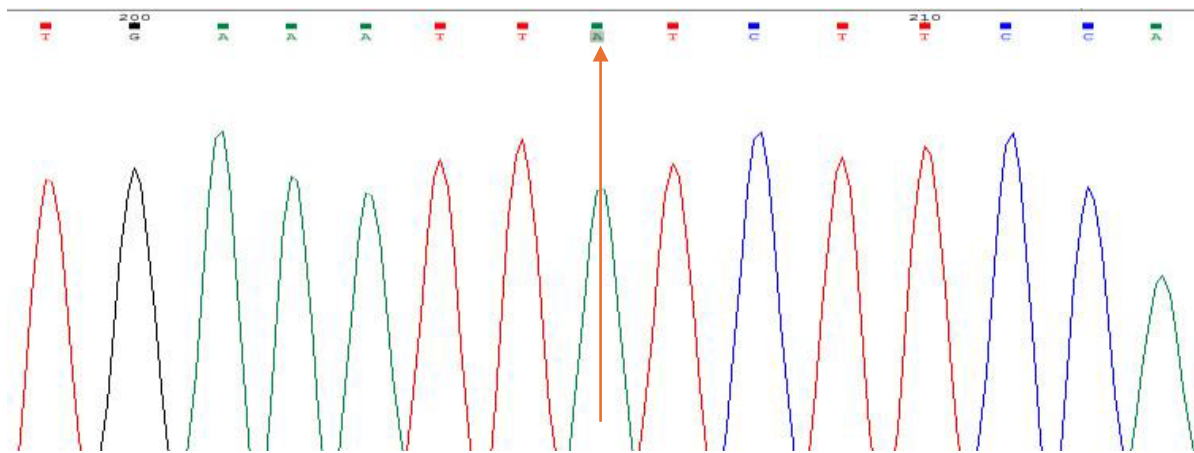

RP304(MM)

RP305 (MN)

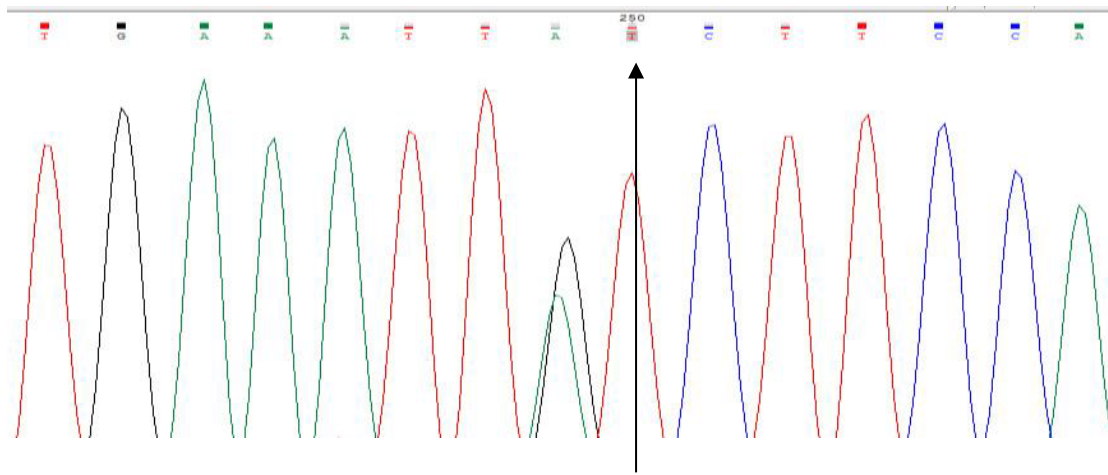

(NN)RP306

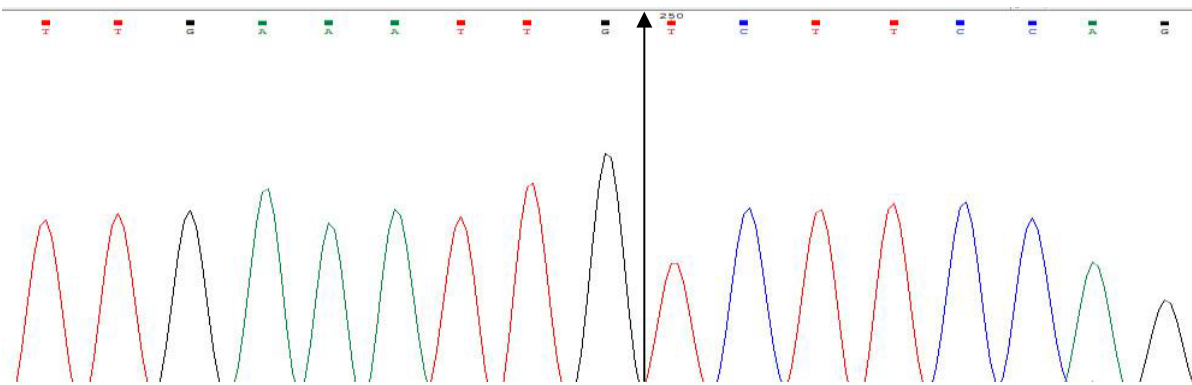

**Family 4**

(MM)RP401

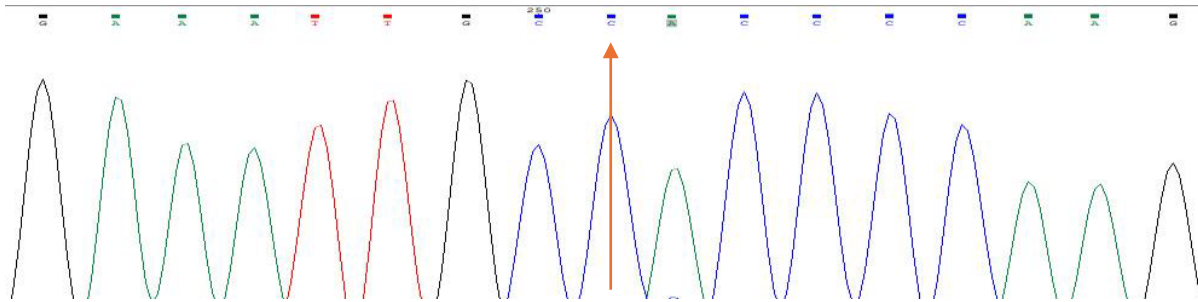

(MM) RP402

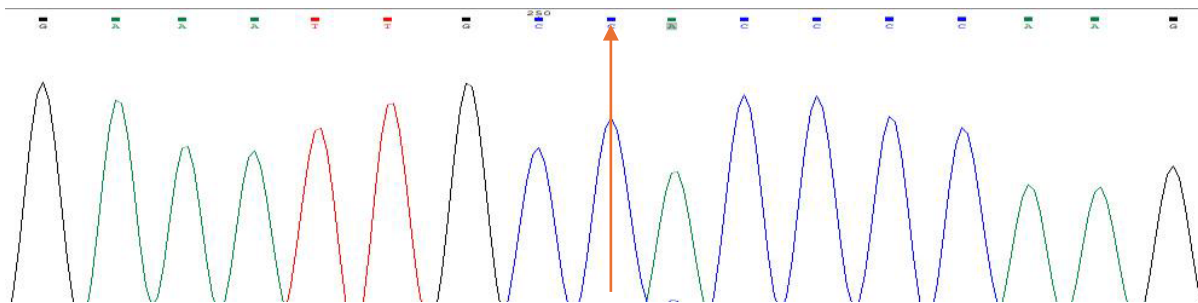

(MM) RP403

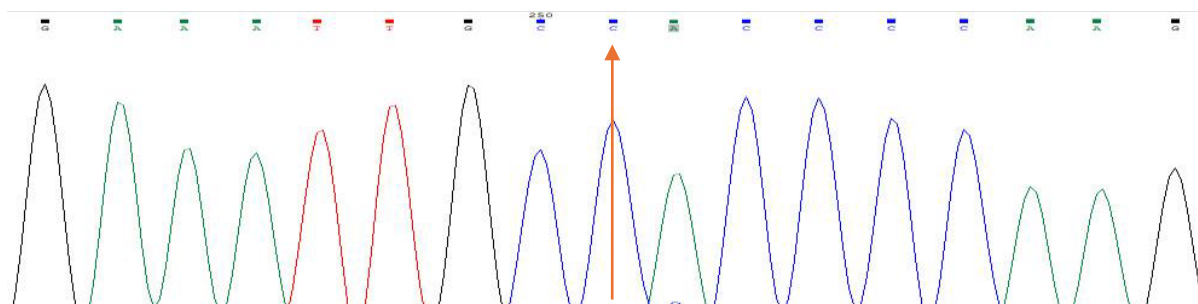

RP404 (MN)

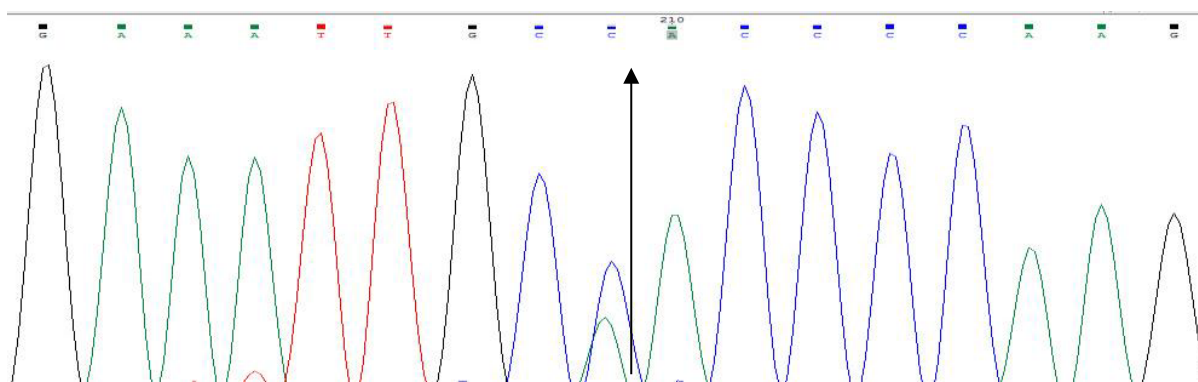

(NN)RP405

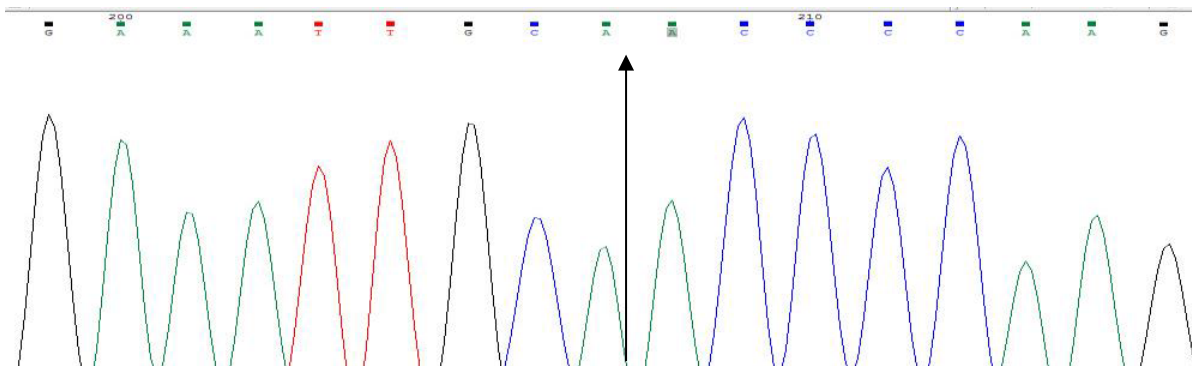

RP406 (MN)

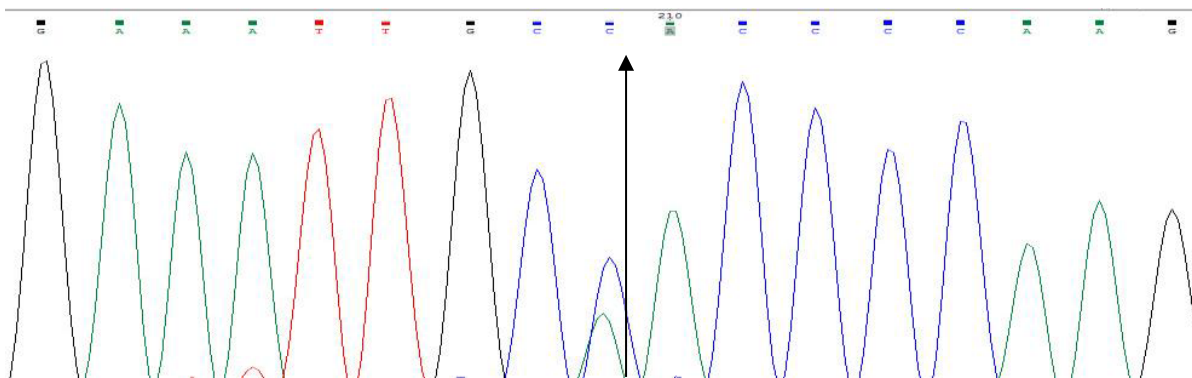

RP407 (MN)

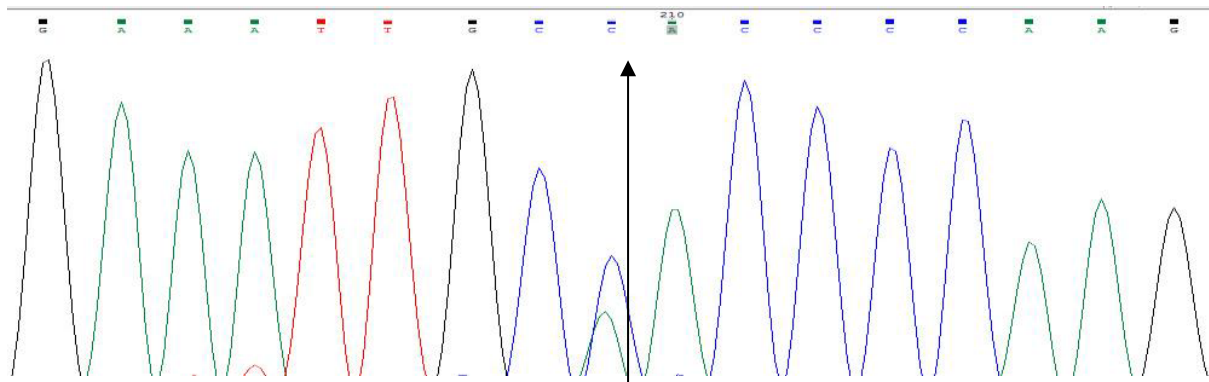



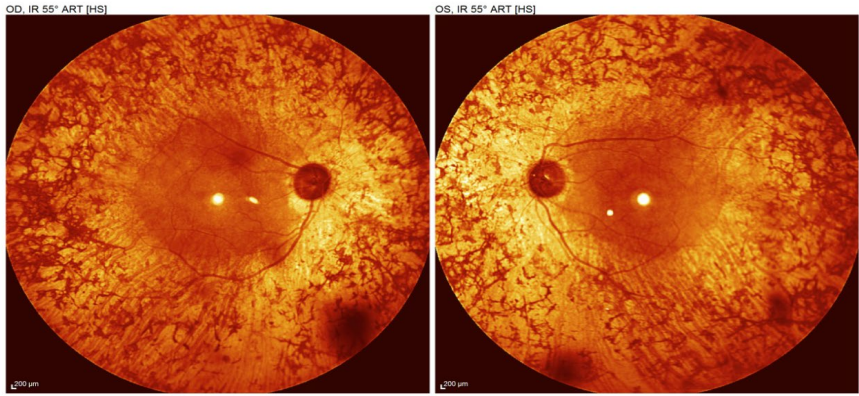

- RP
- ⊕ Down syndrome

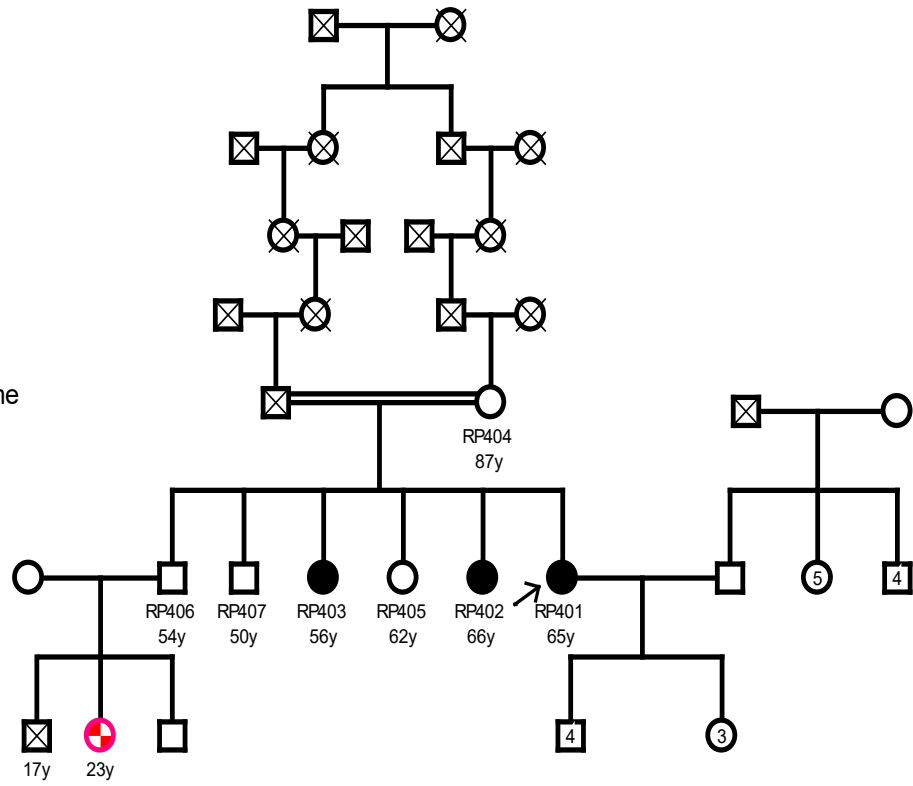

# Family 5

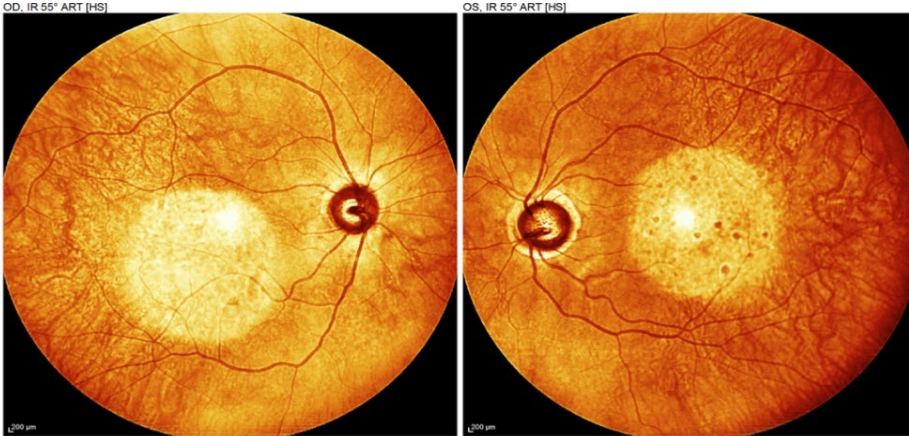

Hemophilia

Night blindness

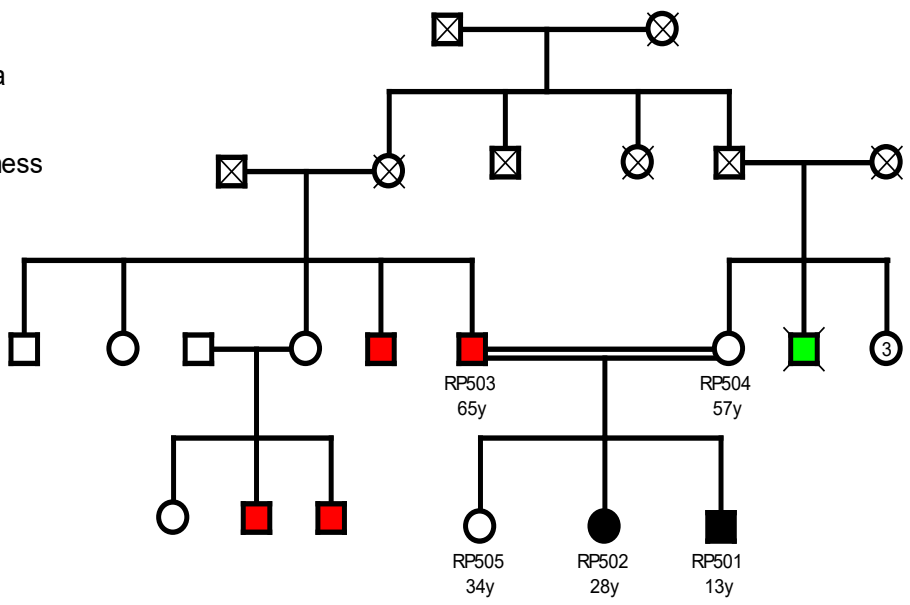

(MM)RP501

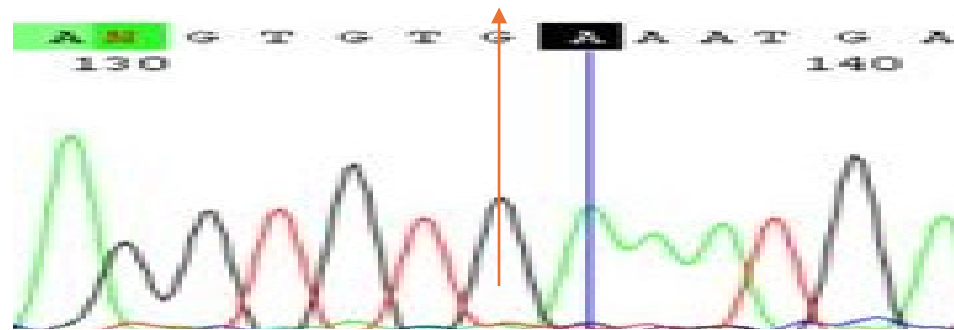

(MM)RP502

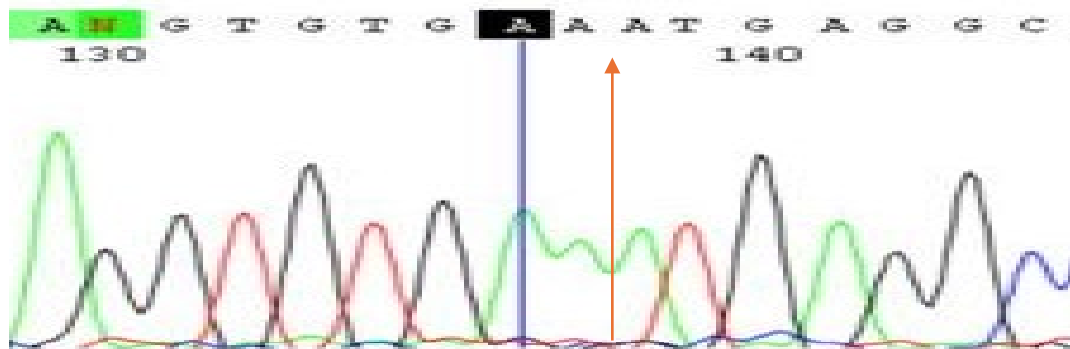

RP503 (MN)

A G **CG** G T G T G **A** A A T G A G  
130 140

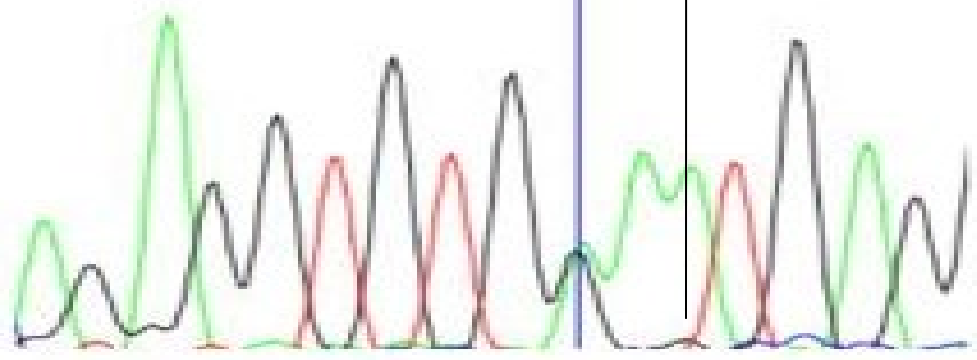

RP504 (MN)

A G **CG** G T G T G **A** A A T G A G  
130 140

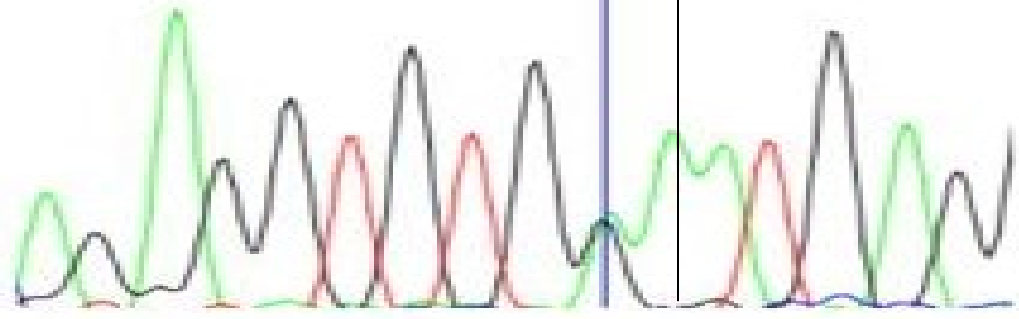

(NN)RP505

